

NUMATICS®

WG Series

Double Guided Wedge Grippers

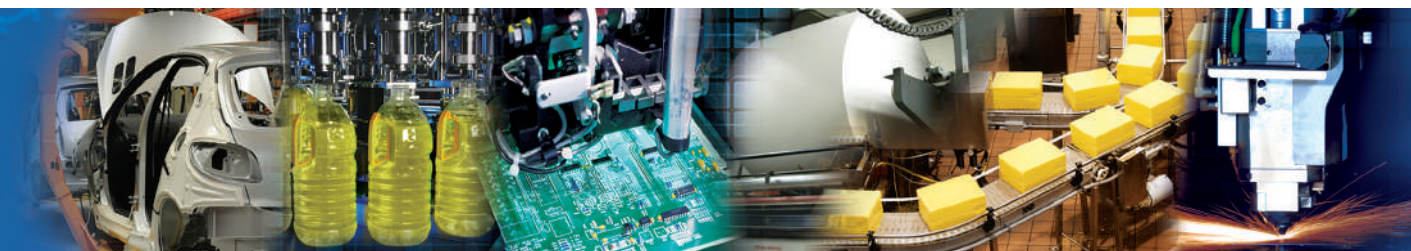
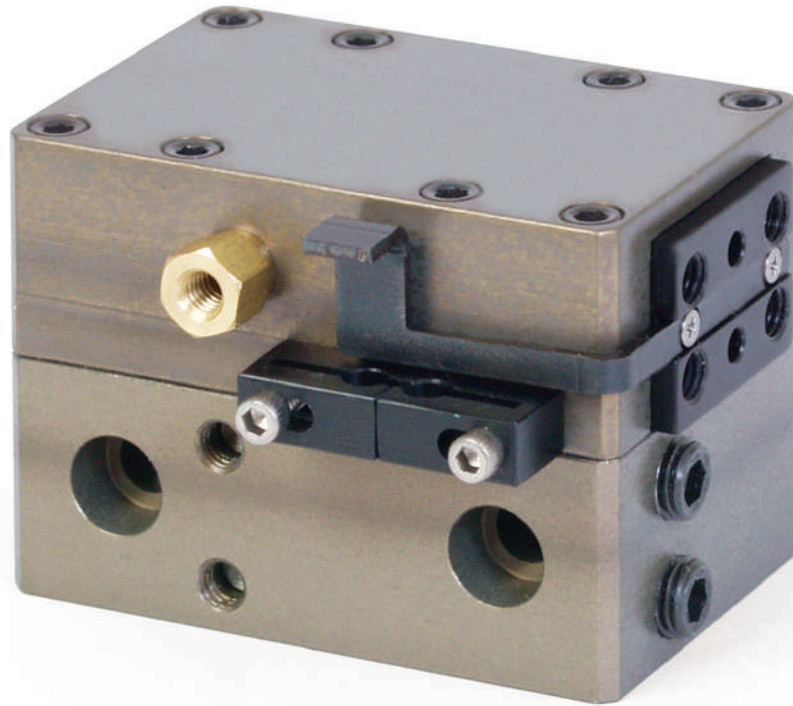

www.numatics.com

WG Series Parallel Gripper

Features & Benefits	3
How To Order	4
WGS50 Dimensions	5
WGS50 Technical Specifications	5
WGL50 & WGS90 Dimensions	6
WGL50 & WGS90 Technical Specification	6
Switch Information	7
Quick Disconnect Cables	8

WGS-50 Parallel Gripper Double Guided Wedge

Gripper summary of Operation:

Synchronous motion is achieved with a double acting piston attached via the piston shaft to a double sided wedge. The double sided angles of the wedge convert vertical motion to synchronous horizontal motion of the jaws.

A. Body

Hardcoat Anodized PTFE impregnated aluminum inside and out. Ultra high gripping force to weight ratio.

B. Jaws

Jaws machined from S7 tool steel to prevent jaw breakage.

C. Switches

Proximity switches are available to monitor open and closed position of the jaws.

D. Side Ports

Additional side mounting holes and side air ports for optional mounting and porting.

E. Lubrication

Pre-lubricated with our specially formulated oil based compound for extensive maintenance free performance.

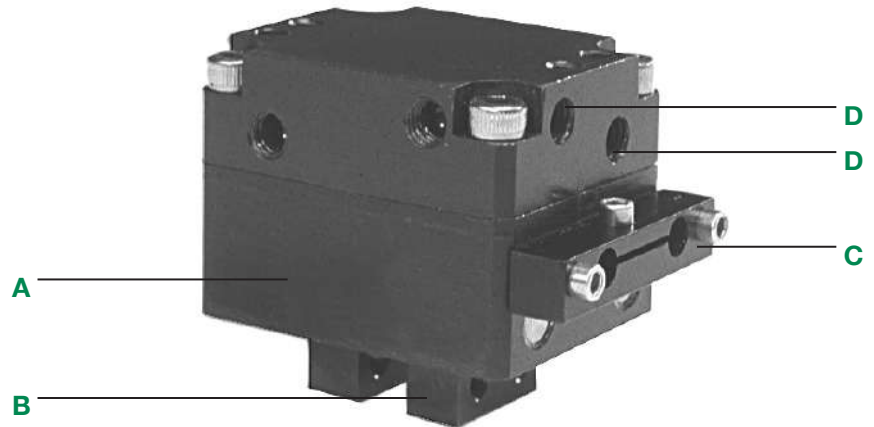

WGL-50 Long Stroke and WGS-90 Short Stroke Parallel Grippers Double Guided Wedge

Gripper summary of Operation:

Synchronous motion is achieved with a double acting piston attached via the piston shaft to a double sided wedge. The double sided angles of the wedge convert vertical motion to synchronous horizontal motion of the jaws.

A. Body

Hardcoat Anodized PTFE impregnated aluminum inside and out. Ultra high gripping force to weight ratio.

B. Jaws

Hardcoat Anodized PTFE impregnated aluminum. Lightweight, Durable, high strength.

C. Purge Port

Unit can be slightly pressurized to prevent debris or coolant from entering. A vacuum can be applied to evacuate contaminants from inside the unit in a clean room environment.

D. Switches

Proximity switches are available to monitor open and closed position of the jaws.

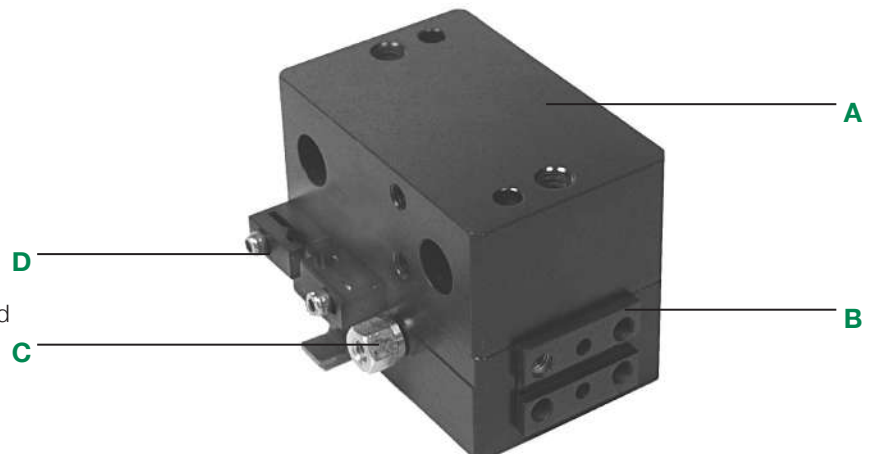

How to Order

WG S 50 1 4 C X

Gripper Stroke

- S = Short stroke
- L = Long stroke

Gripper Series

- 50
- 90

Seal Type

- 1 = Buna-N

Special Options

- X = No Options

Sensing Position

- A = Single Position Open
- B = Single Position Closed
- C = Open and Close Position Sensing
- D = No Sensing

Sensing Type

- Standard Cord Set
 - 4 = Prox Switch - PNP (sourcing)
 - 5 = Prox Switch - NPN (sinking)
 - 6 = No Sensing
 - Quick Disconnect Cord Set
 - W = Prox Switch - PNP (sourcing)
 - V = Prox Switch - NPN (sinking)
 - U = Prox Switch - PNP (sourcing) 90 Deg.
 - T = Prox Switch - NPN (sinking) 90 Deg.
- Prox switches are 4mm diameter

When ordering additional switches:

Switch Description	Standard Part No.	Quick Disconnect Part No.
Prox Switch - PNP (Sourcing)	PROX-4FL2-P	PROX-4QDS-P
Prox Switch - NPN (Sinking)	PROX-4FL2-N	Not Available
Quick disconnect cable straight	-	PXCST
Quick disconnect cable 90 deg.	-	PXC90

Dimensions: Inches

WGS-50

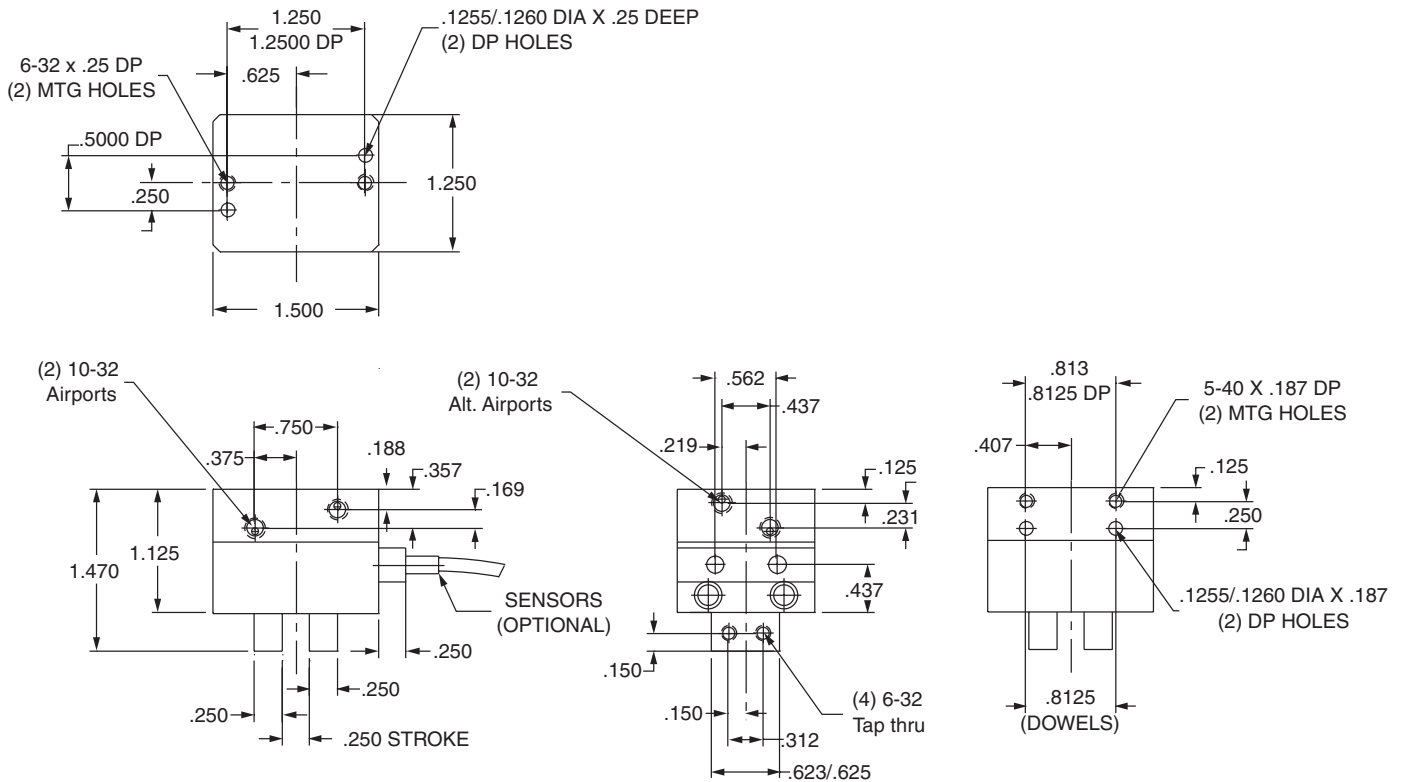

Gripper Specifications

Model	Force Open @100 PSI	Force Close @100 PSI	Displacement	Max. PSI	Repeatability	Weight
WGS-50	45 lbs	40 lbs.	.10 cu. inches	150 PSI	±.002	4 oz.

Recommended Maximum Load Rating

Model	Mx	My	Mz
WGS-50	123 in.-lbs.	123 in.-lbs.	123 in.-lbs.

Grip Force vs. Finger Length

"L" Max	Force Close @ 100 PSI
.05	42 lbs.
1.0	34 lbs.
1.5	30 lbs.
2.0	20 lbs.
2.5	16 lbs.

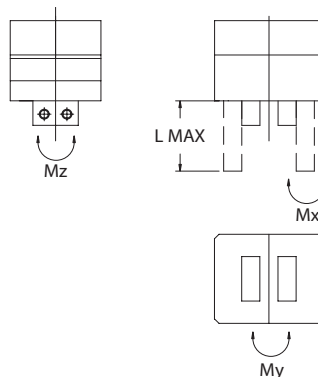

WGS-50

Gripping Force Chart
Per Finger @ 80 PSI

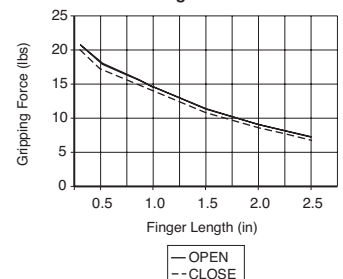

WGL-50

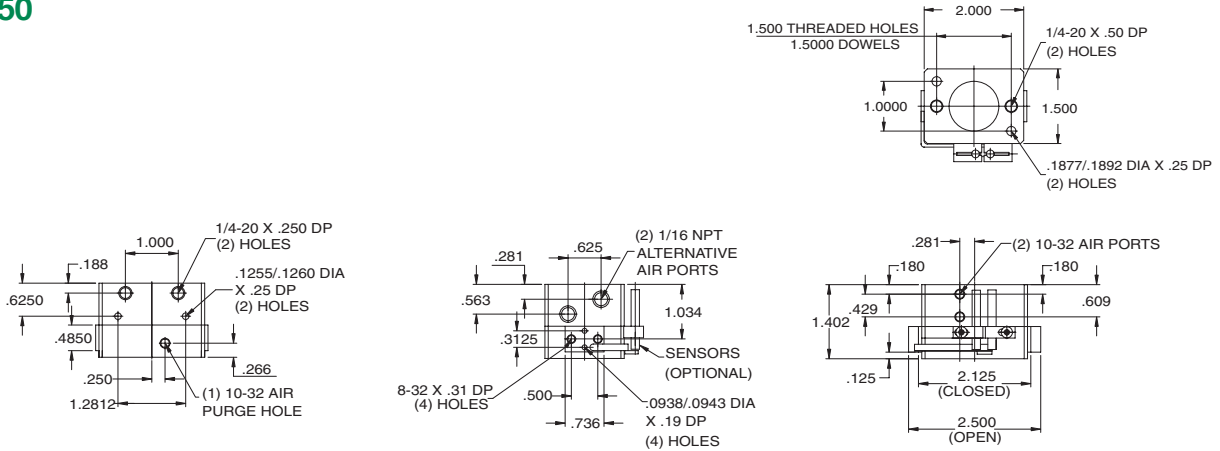

WGS-90

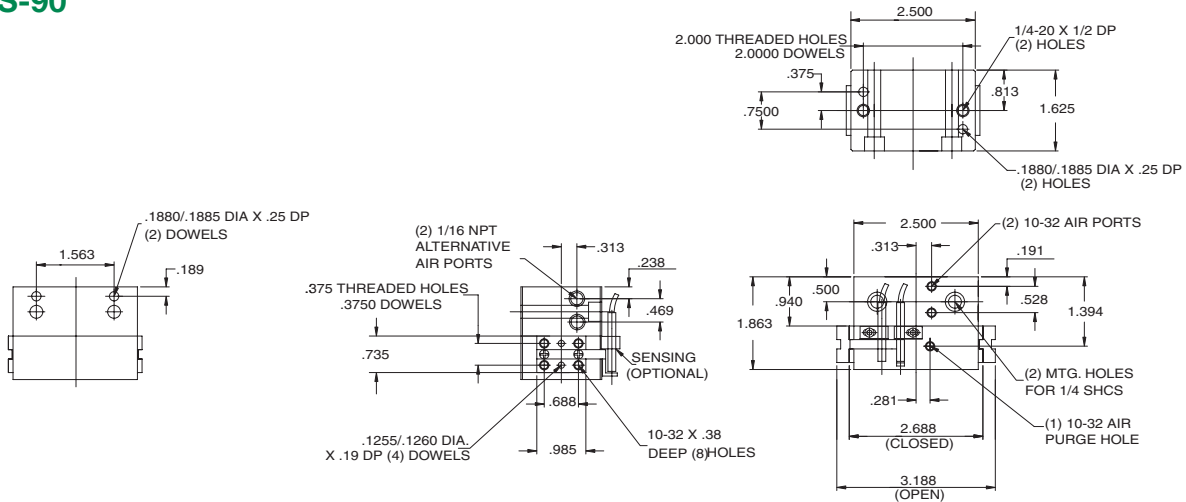

Gripper Specifications

Model	Stroke	Force Close @100 PSI	Displacement	Max. PSI	Repeatability	Weight
WGL-50	.375	40 lbs.	.20 cu. inches	150 PSI	±.002	7 oz.
WGS-90	.500	70 lbs.	.30 cu. inches	150 PSI	±.002	11 oz.

Recommended Maximum Load Rating

Model	Mx	My	Mz	Lmax
WGL-50	70 in.-lbs.	70 in.-lbs.	70 in.-lbs.	2.5 inches
WGS-90	160 in.-lbs.	160 in.-lbs.	160 in.-lbs.	2.5 inches

Grip Force vs. Finger Length

"L" Max	WGL-50	WGS-90
0.05	50 lbs.	92.5 lbs.
1.0	47 lbs.	90 lbs.
1.5	42 lbs.	80 lbs.
2.0	40 lbs.	75 lbs.
2.5	35 lbs.	70 lbs.

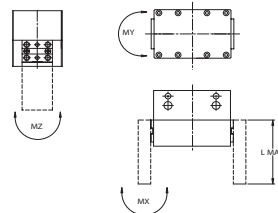

WGL-50

Gripping Force Chart
Per Finger @ 80 PSI

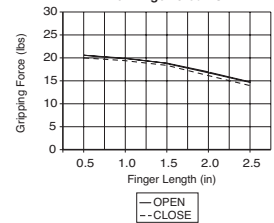

WGS-90

Gripping Force Chart
Per Finger @ 80 PSI

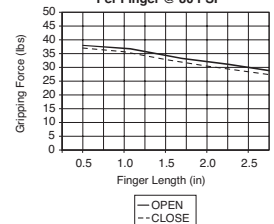

WG Series Switch Information

WG Series Gripper

Series	Bracket P/N
WGS90	CT-500
WGL50	CT-500

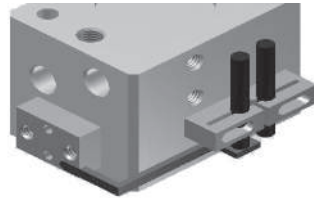

Sensor Description	Standard Cord Set	Quick Disconnect
Prox PNP	PROX-4FL2-P	PROX-4QDS-P
Prox NPN	PROX-4FL2-N	Not Available

See below for sensor specifications

Prox Switch (NPN NO) Flying Lead - PROX-4FL2-N Prox Switch (PNP NO) Flying Lead - PROX-4FL2-P

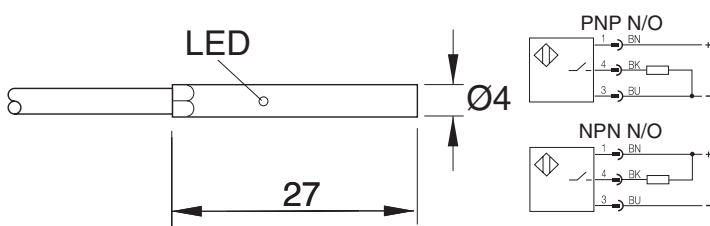

Electrical Design	3-Wire DC PNP/NPN
Output	Normally Open
Operating Voltage	10-36 VDC
Current Rating	100 mA
Short-Circuit Protection	Yes (Non-Latching)
Overload Protection	Yes
Reverse Polarity Protection	Yes
Voltage Drop	< 2.5V
Current Consumption	< 15 mA @ 24V
Real Sensing Range	.8mm ± 10%
Switching Frequency	> 2000 Hz
Ambient Temperature Protection	-25°C to 70°C
Switch-Point Drift	IP 65, III
Hysteresis	-10 - 10% OF Sr
Operating Distance	1 - 15% OF Sr
Correction Factor	0 - .65mm
Housing Material	Mild Steel=.1, Stainless Steel=.7,
Function Display Switching Status	Brass=.5, Alum.=.4, Copper=.3
Connection	Housing; Stainless Steel: POM
	Yellow LED
	PVC Cable, 2m, 3 x .14mm2

Prox Switch (PNP NO), 8 mm connector - PROX-4QDS-P

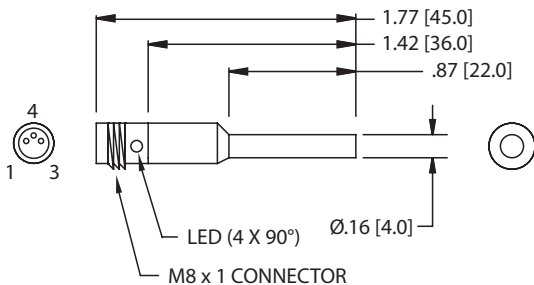

Electrical Design	3-Wire DC PNP
Output	Normally Open
Operating Voltage	10-36 VDC
Current Rating	100 mA
Short-Circuit Protection	Yes (Non-Latching)
Overload Protection	Yes
Reverse Polarity Protection	Yes
Voltage Drop	< 2.5V
Current Consumption	< 15 mA @ 24V
Real Sensing Range	.8mm ± 10%
Switching Frequency	> 2000 Hz
Ambient Temperature Protection	-25°C to 70°C
Switch-Point Drift	IP 65, III
Hysteresis	-10 - 10% OF Sr
Operating Distance	1 - 15% OF Sr
Correction Factor	0 - .65mm
Housing Material	Mild Steel=.1, Stainless Steel=.7,
Function Display Switching Status	Brass=.5, Alum.=.4, Copper=.3
Connection	Housing; Stainless Steel: POM
Remarks	Red LED (4 x 90°)
Accessories	M8 Connector
Agency Approvals	cULus-Class 2 Source Required
	Mounting Clamp



*Switches are not designed for wet environments. Please see your distributor for additional information.

Quick Disconnect Cables

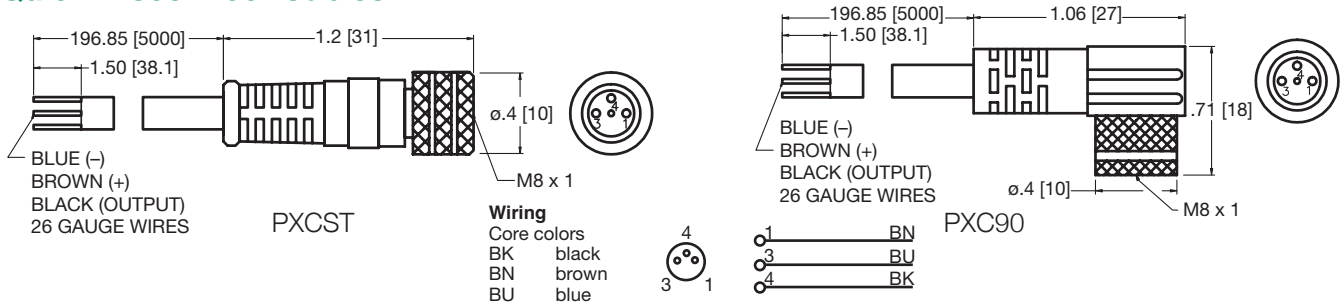

Order Code	Type	Operating Voltage	Current Rating	Cable Material	Protection	Connector
PXCST	Straight 5 m Cable (3 x 26 Gauge wire)	60 AC/75 DC	3 A	PUR	IP 68, III	M8
PXC90	90° 5 m Cable (3 x 26 Gauge wire)	60 AC/75 DC	3 A	PUR	IP 68, III	M8



World Class Supplier of Pneumatic Components



World Headquarters

USA Numatics, Incorporated

46280 Dylan Drive
Novi, Michigan 48377

P: 248-596-3200
F: 248-596-3201

Canada Numatics, Ltd

P: 519-758-2700
F: 519-758-5540

México - Ascomatica SA de CV

P: 52 55 58 09 56 40 (DF y Area metropolitana)
P: 01 800 000 ASCO (2726) (Interior de la República)
F: 52 55 58 09 56 60

Brazil Ascoval Ind.e Comercio Ltda

P: (55) 11-4208-1700
F: (55) 11-4195-3970