

GENERAL

PROTECTION

AND STATUS INDICATORS

FLUID	: Air or neutral gas, filtered, lubricated or dry
PRESSURE SETTING	: 0,5 to 10 bar (0,2 - 6 bar on request)
HYSTERESIS	: 0,4 bar at the beginning of adjustment range 1 bar at the end of adjustment range

MAX. PRESSURE (PMA)	: 10 bar or 16 bar
OPERATING TEMPERATURE	: -10°C; +60°C : 0°C, +60°C
MAX. VOLTAGE	: 250 V - AC/DC : 24 V DC
CURRENT BREAKING CAPACITY	: 5 A - 250 V resistive : 2 A - 24 V DC resistive
PROTECTION DEGREE	: IP65
MOUNTING POSITIONS	: all positions
MAX. SPEED	: 60 cycles per minute

CONSTRUCTION

Bodies: PC (polycarbonate) / aluminium for 16 bar version

Nitrile (NBR) seals

Commutator (reversing switch) • at rest : contact 1 - 2 made
• at work : contact 1 - 3 made

Mechanical service life: 5.10⁶ contacts

Pressure set by set screw and lock-nut

SPECIFICATIONS

Type	Designation	Pressure setting (bar)	catalogue number	
			Without protection	With protection
	Adjustable pressure switch with side pneumatic connection, tapped G1/4	0,2 - 6	34900015	-
		0,5 - 10	34900018	34900019
		0,5 - 16	34900021	-
	Adjustable pressure switch with subbase mounted pneumatic connection (version adaptable on FRL)	0,5 - 10	34900030	34900031

DIMENSIONS AND WEIGHT

Weight: 110 g

Version **without** protection and status indicators

Tapped

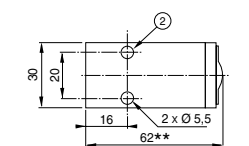

subbase mounted

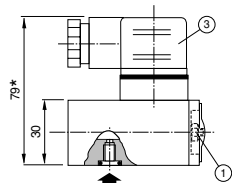
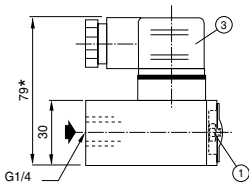
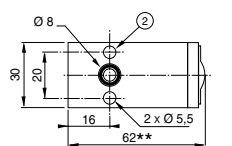

Version **with** protection and status indicators

Tapped

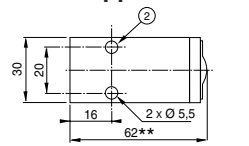

subbase mounted

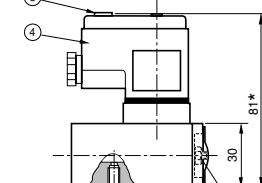
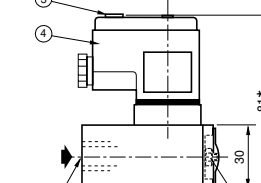
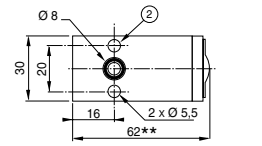

- ① Pressure set screw (spanner for hexagon nuts: 3 mm)
- ② 2 holes Ø 5,5 for mounting
- ③ ISO4400 size 30 connector, 4 terminals, rotatable by 90°
- * +15 mm for connector clearance
- ** +2 mm for 0,5 - 16 bar version

ELECTRICAL DIAGRAM

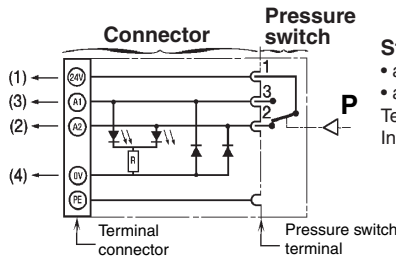

Status indicated by two diodes :

- at rest : contact 1-2 made: orange diode lights
 - at work : contact 1-3 made: red diode lights
- Terminal connection for 1,5 mm² wire
Integrated interference blanking

- ① Pressure set screw (spanner for hexagon nuts: 3 mm)
- ② 2 holes Ø 5,5 for mounting
- ③ Identification label holder
- ④ ISO 4400 size 30 connector, 4 terminals (not rotatable)
- * +15 mm for connector clearance
- ** +2 mm for 0,5 - 16 bar version

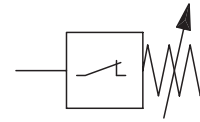

GENERAL

Fluid	Air or neutral gas, filtered, lubricated or dry
Maximum allowable pressure (MAP)	16 bar
Control range	0 - 10 bar
Fluid temperature	-10°C to +60°C
Max. speed	60 cycles per minute
Hysteresis	0,2 bar at the beginning of control range
Mechanical service life	10 ⁶ contacts
Mounting positions	All positions

CONSTRUCTION

Body	Steel
Seals	FPM (fluoroelastomer)
Pressure set	By set screw

ELECTRICAL CHARACTERISTICS

Max. switched voltage	48 V DC
Max. switched current	0,5 A
Electric contact	Plated silver



SPECIFICATIONS

designation		control range (bar)	maximum allowable pressure (MAP) (bar)	catalogue number
Diaphragm pressure switch, NC, adjustable, pneumatic connection	G 1/8	1 - 10	16	34900048
	G 1/4			34900049

DIMENSIONS (mm), WEIGHT (kg)

weight
0,065

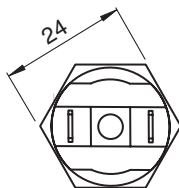
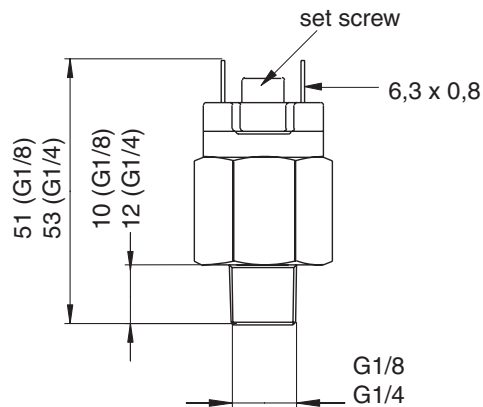

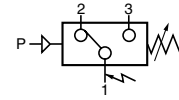

GENERAL

FLUID : air or neutral gas, filtered, not lubricated, free of condensate
 CONNECTION : G1/8
 PRESSURE RANGE : 0 to 10 bar
 MAX. OVERPRESSURE : 15 bar
 OPERATING TEMPERATURE : 0°C, +50°C (storage: -20°C, +60°C)
 ELECTRICAL CONNECTION : 4-pin M8 connector
 SUPPLY VOLTAGE : 12 to 24 volts, max. ripple 10%, reverse voltage protection
 CONSUMPTION : < 55mA
 VOLTAGE SPIKE : 350 V Peak, 1µs
 ACCURACY : +/- 200 mbar (2% of full range)
 DIGITAL DISPLAY : 3-digit - 7 segments - display frequency : 5 Hz
 UNITS OF MEASURE : bar - psi - MPa - kgf/cm²
 OUTPUTS : 2 PNP outputs selectable NO or NC, max. load current 80 mA, 30 V, with overcurrent protection, status indication by LED

2 OUTPUT MODES

RESPONSE TIME : < 2,5 ms - 24 ms - 192 ms - 768 ms
 PROTECTION DEGREE : IP65
 VIBRATION RESISTANCE : 10 to 55 Hz, 1.5 mm, XYZ, 2 hours
 SHOCK RESISTANCE : 980 m/s² (100G), XYZ

CHARACTERISTICS

Recording of peak value and bottom value
 Lockout feature

CONSTRUCTION

Polycarbonate body (PC)
 NBR (nitrile) sealings



OPERATING

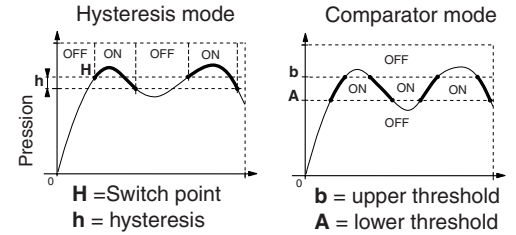

SPECIFICATIONS

description	catalogue number
electronic pressure switch with digital display adjustable from 0 to 10 bar, pneumatic connection G1/8 (delivered with 2 brackets, 1 plug G1/8)	34900050
panel mounting kit for electronic pressure switch	88100967
straight female connector Ø M8, 4 wires, IP65, with 5 m PVC lead (other end plain)	88157771

DIMENSIONS AND WEIGHT

Weight: 105 g

3 1/2" digit LED Display

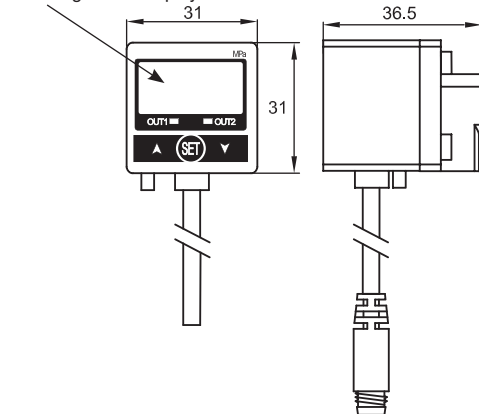

2 inlet pressure ports G1/8

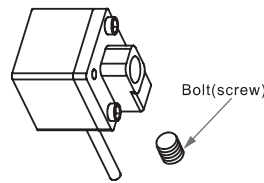

ELECTRICAL DIAGRAM

Pressure switch User connection

PNP output

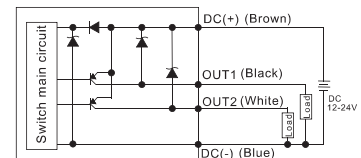

ELECTRICAL CONNECTION

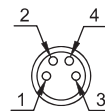

- 1 = brown (V +)
- 2 = white (output 2)
- 3 = blue (V -)
- 4 = black (output 1)

ACCESSORIES

BRACKET MOUNTING

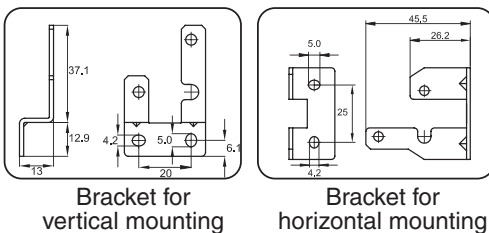

PANEL MOUNTING KIT

