



ACCESSORY VALVES

flow control valve
1/4 - 1/2



Series

800

GENERAL

Operating pressure 0 to 16 bar [1 bar =100 kPa]
Ambient temperature range -20°C to +105°C

fluids (*)	temperature range (TS)	seal materials (*)
clean dry air or dry inert gas	-20°C to +105°C	NBR (nitrile)

MATERIALS IN CONTACT WITH FLUID

(*) Ensure that the compatibility of the fluids in contact with the materials is verified

Body AISI 316L
Seals NBR

SPECIFICATIONS

pipe size	flow coefficient Kv		catalogue number
	(m³/h)	(l/min)	
NPT			
1/4	0,64	10,68	8800A50000N0000
1/2	3,39	56,57	8800A50200N0000



DIMENSIONS (mm), WEIGHT

8800A50000N0000

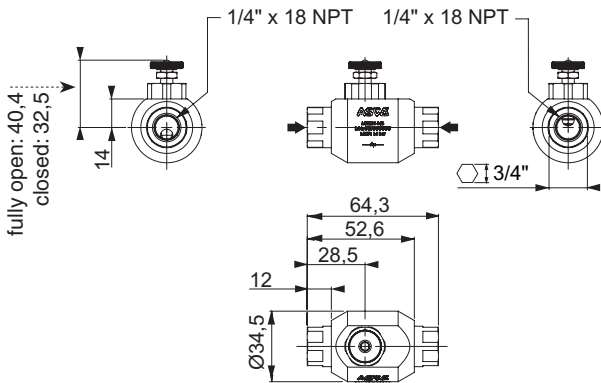

8800A50200N0000

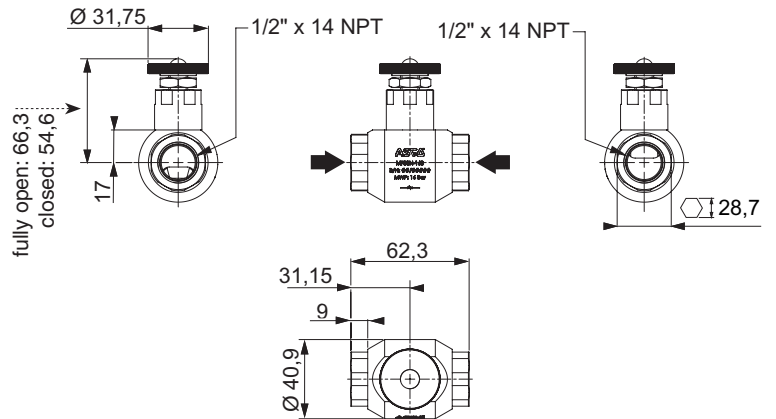

catalogue number	Ø A	weight
8800A50000N0000	1/4 NPT	0,33
8800A50200N0000	1/2 NPT	0,52

