

GENERAL

Operating pressure 1 to 10 bar
Ambient temperature range -10°C to +60°C

fluids (*)	temperature range (TS)	seal materials (*)
air, inert gas, filtered lubricated or not	-10°C to +60°C	NBR (nitrile)

MATERIALS IN CONTACT WITH FLUID

(*) Ensure that the compatibility of the fluids in contact with the materials is verified

Body Aluminium
Seals NBR

SPECIFICATIONS

pipe size	catalogue number
M5	34602010
G 1/8	34602152
G 1/4	34602153
G 3/8	34602154
G 1/2	34602155
G 3/4	34600156



DIMENSIONS (mm), WEIGHT (kg)



M5 to G1/2

G3/4

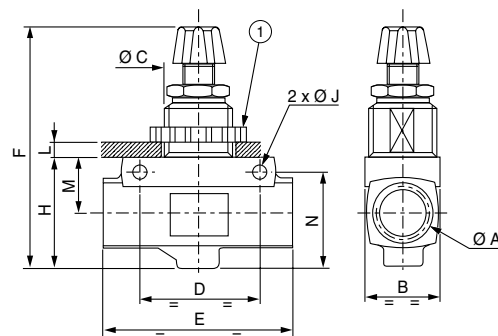
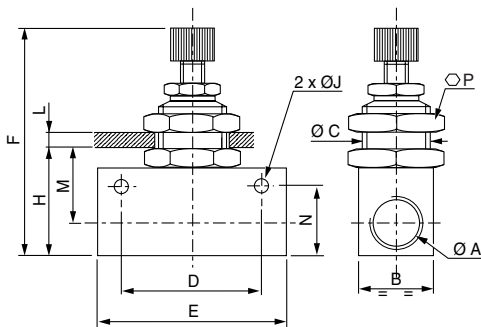

catalogue number	Ø A	B	Ø C	D	E	F min.	F max.	H	Ø J	L max.	M	N	Ø P	weight
34602010	M5	12	M9 x 0,75	18	25	32	37	17	3,2	3	10	12	11	0,019
34602152	G 1/8	16	M12 x 0,75	24	34	49	56	24	4,5	6	16	16	15	0,060
34602153	G 1/4	25	M18 x 1,5	35	50	67	75	35	6,5	7,5	23	25	22	0,140
34602154	G 3/8	25	M18 x 1,5	40	58	67	75	35	6,5	7,5	23	25	22	0,245
34602155	G 1/2	30	M22 x 1,5	50	65	80	92	46	6,5	10	29	33	26	0,360
34600156	G 3/4	39	M37 x 2	70	110	119	132	58	6,5	15,5	28	51	-	0,550

① Knurled nut



FEATURES

- Banjo connection for direct fitting to cylinder port for simple, compact installation
- Version (B) with a recessed adjustment screw is an even more compact design. It offers the additional advantage of preventing inadvertent loss of flow adjustment. Can be locked with a spot of varnish

GENERAL

Operating pressure 1 to 10 bar
Ambient temperature range 0°C to +70°C

fluids (*)	temperature range (TS)	seal materials (*)
air, inert gas, filtered, lubricated or not	0°C to +70°C	NBR (nitrile)

MATERIALS IN CONTACT WITH FLUID

(*) Ensure that the compatibility of the fluids in contact with the materials is verified

Body Polymer (A and B versions) or brass (version C)
Screw, lock-nut, subbase Brass
Seals NBR

SPECIFICATIONS

pipe size	Ø connection by instant fittings	catalogue number	pipe size	Ø connection threaded	catalogue number
A Plastic body, adjustable by button/screw			C Metal body, threaded outlet, adjustable by button/screw		
Ø M5	Ø 4 mm ext.	34602188	G 1/8	G 1/8	34602181
G 1/8	Ø 4 mm ext.	34602221	G 1/4	G 1/4	34602182
G 1/8	Ø 6 mm ext.	34602222	G 3/8	G 3/8	34602183
G 1/4	Ø 6 mm ext.	34602223			
G 1/4	Ø 8 mm ext.	34602224			
G 3/8	Ø 10 mm ext.	34602021			
G 1/2	Ø 12 mm ext.	34602022			
B Plastic body, adjustable by recessed screw					
Ø M5	Ø 4 mm ext.	34602016			
G 1/8	Ø 4 mm ext.	34602017			
G 1/8	Ø 6 mm ext.	34602018			
G 1/4	Ø 6 mm ext.	34602019			
G 1/4	Ø 8 mm ext.	34602020			



DIMENSIONS (mm), WEIGHT (kg)

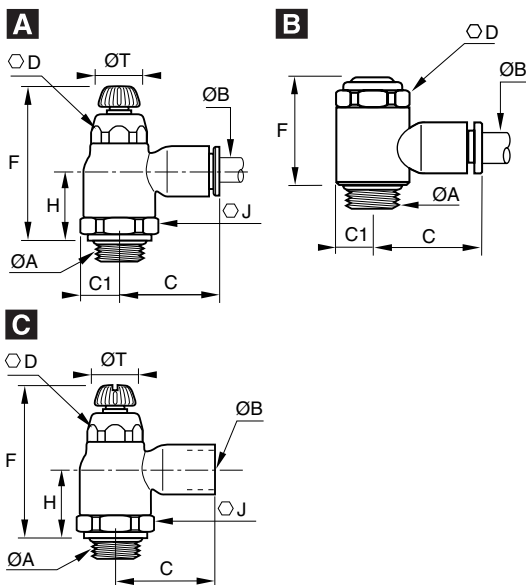

CODES	ØA	ØB	C	C1	D	F min.	F max.	H	J	ØT	Weight
A Plastic body, instant fitting outlet, adjustable by button/screw											
34602188	M 5	4	17	4,5	6	23,5	26	-	-	-	0,008
34602221	G 1/8	4	22	9	10	38	44	16	16	10	0,021
34602222	G 1/8	6	22	9	10	38	44	16	16	10	0,021
34602223	G 1/4	6	22	9	10	36,5	42,5	15	16	10	0,021
34602224	G 1/4	8	28	10,5	14	41,5	48	18,5	19	12	0,037
34602021	G 3/8	10	32	12,5	17	45,5	54	20	23	17	0,059
34602022	G 1/2	12	35	13	17	45,5	54	20	24	17	0,065
B Plastic body, instant fitting outlet, adjustable by recessed screw											
34602016	M 5	4	19	5	8	17,5	19	-	-	-	0,007
34602017	G 1/8	4	19	7	13	25	26	-	-	-	0,017
34602018	G 1/8	6	21	7	13	25	26	-	-	-	0,019
34602019	G 1/4	6	22	9,5	17	26,5	28	-	-	-	0,034
34602020	G 1/4	8	27	9,5	17	26,5	28	-	-	-	0,035
C Metal body, threaded outlet, adjustable by button/screw											
34602181	G 1/8	G1/8	22,5	-	10	47	52,5	23	19	-	0,076
34602182	G 1/4	G1/4	32	-	14	50,5	55,5	25	19	-	0,107
34602183	G 3/8	G3/8	34,5	-	17	56	62	27	25	-	0,212